











- 真直度
-  平面度
- 高円度
-  円筒度
-  平行度
-  直角度
-  位置度
-  同軸度
-  対称度
-  振れ

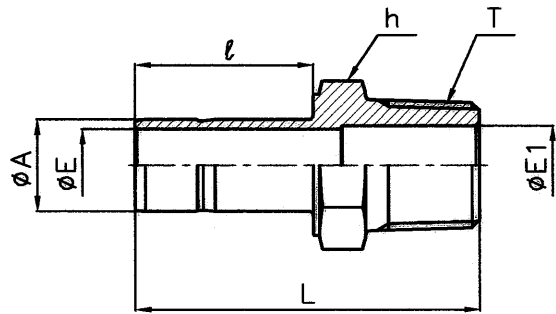

Part No	A TUBE OD	T (NPT)	E	E1	h (HEX)	ℓ	L	
MDHA 3M- 2ss	3	1/8	1.5	4.8	12	14.0	29.2	
MDHA 4M- 2ss	4	1/8	2.5	4.8	12	15.0	30.2	
MDHA 4M- 4ss		1/4		7.1				35.0
MDHA 6M- 2ss	6	1/8	4.0	4.8	12	16.5	31.7	
MDHA 6M- 4ss		1/4		7.1				36.5
MDHA 6M- 6ss		3/8		10.4				38.3
MDHA 6M- 8ss		1/2		12.7				42.8
MDHA 8M- 2ss		8		1/8				6.4
MDHA 8M- 4ss	1/4		7.1	37.1				
MDHA 8M- 6ss	3/8		10.4	39.0				
MDHA 8M- 8ss	1/2		12.7	43.5				
MDHA10M- 4ss	10		1/4	8.0	7.1	14	18.0	
MDHA10M- 6ss		3/8	10.4		39.8			
MDHA10M- 8ss		1/2	12.7		44.3			

△						品番	図番	名称	個数	材質	備考
△						材質	SUS316		処理		
△						検図		承認		MDHA***M-***ss ①	
△						関連図番				METRIC BI-LOKアダプター (~10M)	
△						設計		製図		尺度	NTS
記号	記	事	日付	変更	確認	図番		番		MDHA***M-*** 	
来歴	△ 参考図表示見直しによる全面書き換え(分割)					イハラサイエンス株式会社					

普通寸法差 (削り加工) (中級)			
寸法区分 mm	寸法差 mm	寸法区分 mm	寸法差 mm
1以上 4以下	± 0.1	250%以上 1000%以下	± 0.8
4%以上 16%以下	± 0.2	1000%以上 2000%以下	± 1.0
16%以上 63%以下	± 0.3	2000%以上 4000%以下	± 1.5
63%以上 250%以下	± 0.4		